

# Renewable Energy & Hydroelectric Works

8<sup>th</sup> semester, School of Civil Engineering

2<sup>nd</sup> semester, Master's Programme "Water Resources Science & Technology"

## Penstocks & turbines



**A. Efstratiadis, G.-K. Sakki, & D. Koutsoyiannis**

**Department of Water Resources & Environmental Engineering, NTUA**

**Academic year 2021-22**

# Sketch of conventional hydropower system

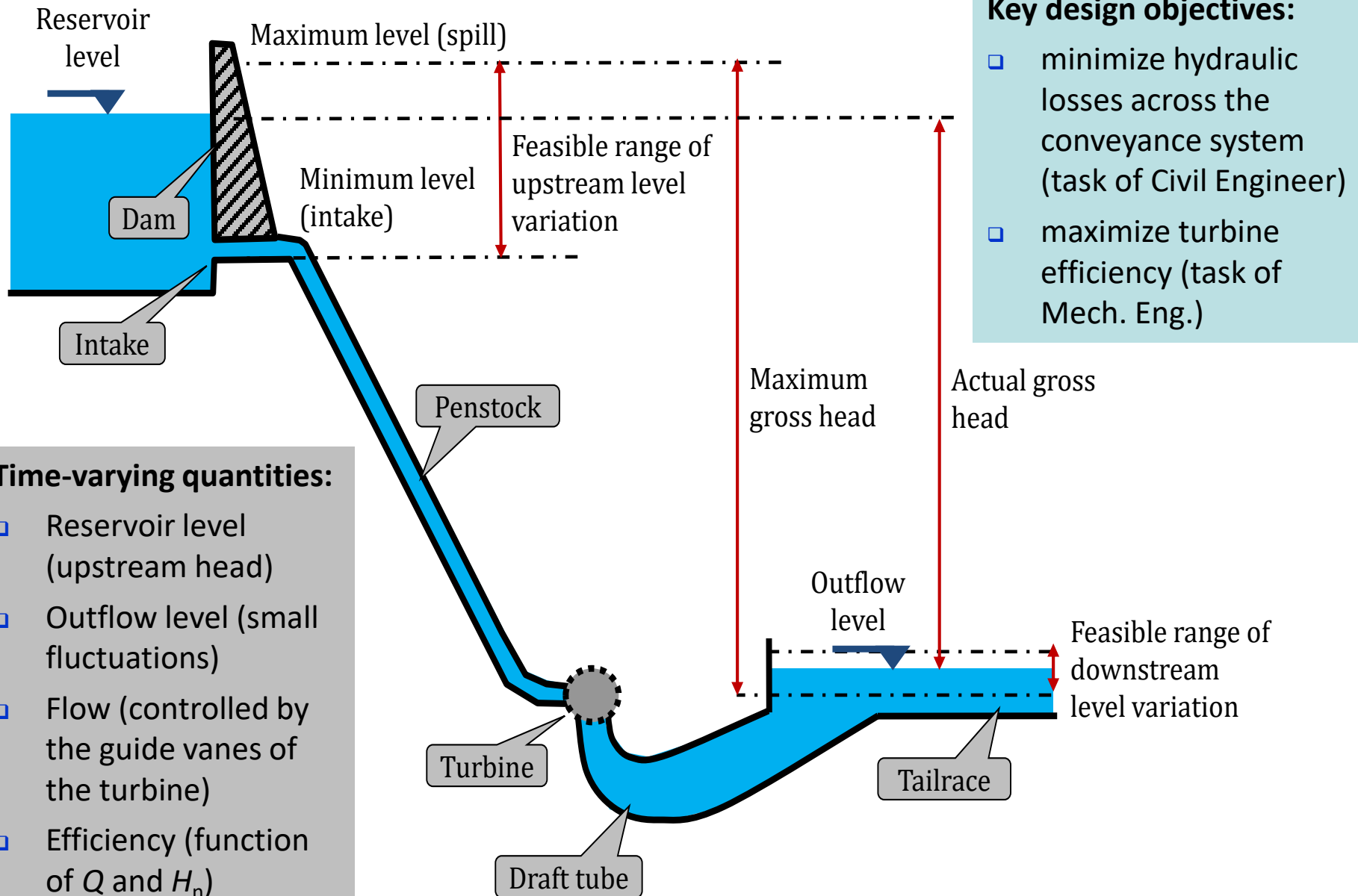

# Penstocks: Layout and design criteria

- Pipes of **large diameter** (usually **steel**), conveying water from the source (reservoir or forebay) to the power house.
- Usually **high-pressure pipelines** designed to withstand stresses due to **static and water hammer pressures**, created by sudden changes in power demands.
- In case of **long distances**, a high-pressured pipe is very uneconomical, thus the conveyance system can be divided in two parts:
  - a long low-pressure tunnel or a headrace canal;
  - a short high-pressure pipeline (penstock) close to the turbine unit, separated by a surge chamber to absorb the water hammer pressure rises and convert them into mass oscillations.
- Design driven by combined minimization of **construction costs** and lost revenue due to **energy losses** (function of geometry, mainly of diameter and length) .

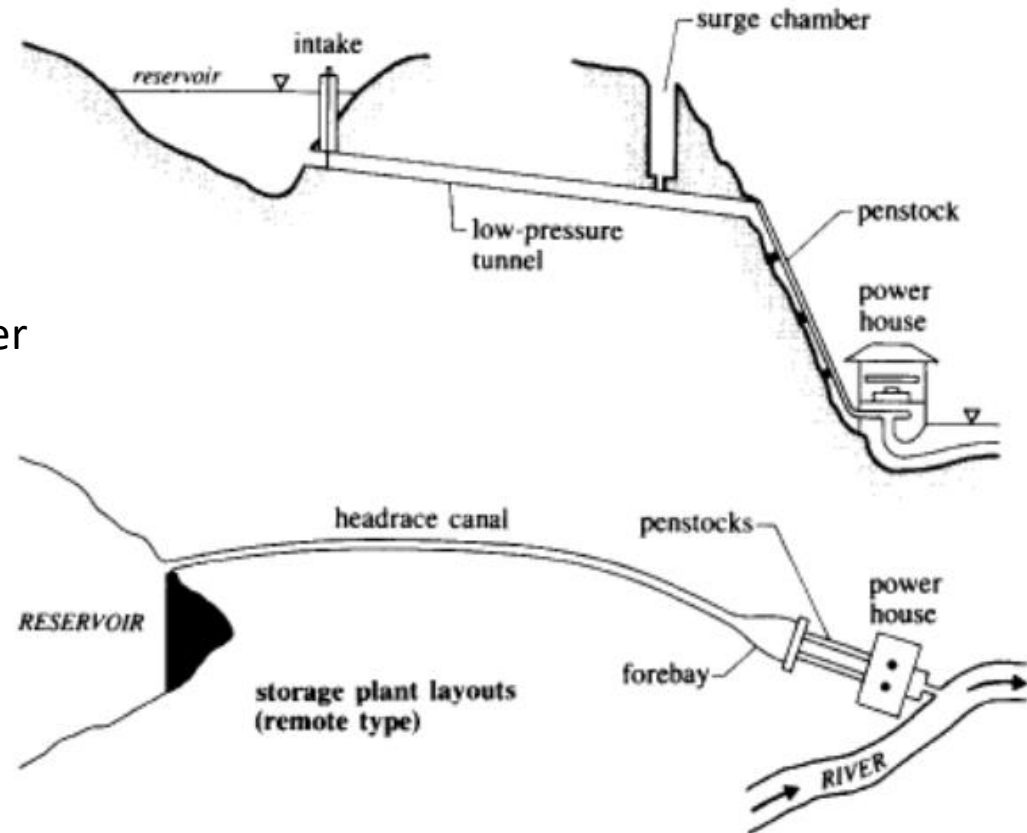

**Source:** Novak, P., A.I.B. Moffat, C. Nalluri, and R. Narayanan, *Hydraulic Structures*, 2<sup>nd</sup> edition, 1996.

# Types of penstocks

---

## □ Hydraulic tunnels:

- Large discharge capacity
- Pressured tunnels, lined (shotcrete-gunitite, concrete, reinforced concrete, steel) or not (only in case of compact rock) → water and energy losses (roughness)
- Alternative: steel pipes embedded into tunnels
- Difficult construction in case of steep slopes

## □ Surface (exposed):

- Located above the ground, supported by anchorages and rings
- Expansion joints are necessary for longitudinal stresses
- Economic solution for rocky terrains and large diameters
- Easy to inspect faults and employ common maintenance
- Direct exposure to environment and weather effects

## □ Underground:

- Partially or fully buried (expensive, for large diameters)
- Supported in the soil in a stretch of 1.0-1.5 m depth
- Conservation of natural landscape
- Protection from landslide and storms

# Examples of hydropower tunnels

<https://www.ntnu.edu/hydrocen/swelling-rocks-and-hydropower-tunnels>



<https://www.nazret.com/2016/12/02/inside-ethiopia-gibe-iii-hydroelectric-project/>



# Surface penstocks

Plastiras



Plastiras

Theodoriana



Glafkos



Plastiras



# Brief overview of pipe hydraulics: Friction losses

---

- For given discharge,  $Q$ , and pipe diameter  $D$ , the flow velocity is given by:

$$V = \frac{4Q}{\pi D^2}$$

- The energy gradient,  $J = h_f/L$ , is estimated by the **Darcy-Weisbach equation**:

$$J = f \frac{1}{D} \frac{V^2}{2g}$$

where  $f$  is a (dimensionless) friction factor, depending both on pipe properties and flow conditions. For turbulent flow, the **friction factor** is typically estimated by the (empirical) **Colebrook-White equation**:

$$\frac{1}{\sqrt{f}} = -2 \log \left( \frac{\varepsilon}{3.7D} + \frac{2.51}{Re \sqrt{f}} \right)$$

where  $Re := V D/\nu$  is the **Reynolds number** and  $\varepsilon/D$  is the **relative roughness**, both dimensionless quantities, whereas  $\varepsilon$  is the **absolute roughness** of the pipe and  $\nu$  is the **kinematic viscosity of water**, which is function of temperature; e.g., for  $T = 15^\circ\text{C}$ ,  $\nu = 1.1 \times 10^{-6} \text{ m}^2/\text{s}$ .

- For a penstock of length  $L$ , and by considering steady uniform flow with discharge  $Q$  and diameter  $D$ , the friction losses are given by:

$$h_f = fL \frac{8Q^2}{\pi^2 g D^5}$$

# Simplified expressions for friction losses

- Due to the complexity of friction loss calculations via the Colebrook-White equation, a number of simplified formulas have been developed in the literature. A consistent and accurate approximation is offered by the so-called **generalized Manning formula**, i.e.:

$$J = \left( \frac{4^{3+\beta} N^2 Q^2}{\pi^2 D^{5+\beta}} \right)^{1/(1+\gamma)}$$

where  $\beta$ ,  $\gamma$  and  $N$  are coefficients depending on roughness, for which Koutsoyiannis (2008) provides analytical expressions that are valid for specific velocity and diameter ranges.

- For **large diameters** (i.e.,  $D > 1$  m) and **velocities** (i.e.,  $V > 1$  m/s) that are typically applied in hydropower systems, we get:

$$\beta = 0.25 + 0.0006 \varepsilon_* + \frac{0.024}{1+7.2\varepsilon_*}, \quad \gamma = \frac{0.083}{1+0.42\varepsilon_*}, \quad N = 0.00757 (1 + 2.47\varepsilon_*)^{0.14}$$

where  $\varepsilon_* := \varepsilon/\varepsilon_0$  is the so-called normalized roughness and  $\varepsilon_0 := (v^2/g)^{1/3} = 0.05$  mm, for temperature 15 °C.

- The roughness coefficient,  $\varepsilon$ , is a characteristic hydraulic property of the pipe, mainly depending on the pipe material and age, where aging also depends on water quality. For **design purposes**, it is recommended to apply quite large roughness values, e.g.  $\varepsilon = 1$  mm, in order to account for all above factors at the end of time life of the penstock. For the above value, we get  $\varepsilon^* = 1/0.05 = 20$ , and thus  $\beta = 0.262$ ,  $\gamma = 0.009$ , and  $N = 0.0131$ .

**More info:** Koutsoyiannis, D., A power-law approximation of the turbulent flow friction factor useful for the design and simulation of urban water networks, *Urban Water Journal*, 5(2), 117-115, doi:10.1080/15730620701712325, 2008.



# Local (minor) energy losses

---

- **Local**, also referred to as **minor hydraulic losses**, are occurring at every **change of geometry and thus change of the flow conditions** (e.g. flow entrance through the intake, change of diameter, flow split, elbow, etc.).
- Geometrical changes (transitions, fittings) and added components interrupt the smooth flow of fluid, causing small-scale hydraulic losses due to **flow separation or flow mixing**.
- Each individual loss is generally estimated by:

$$h_L = k \frac{V^2}{2g}$$

where  $k$  is a dimensionless coefficient, depending on geometry.

- Classical hydraulic engineering handbooks provide analytical relationships, empirical formulas and nomographs, for estimating  $k$  as function of local geometrical characteristics.
- Typical values that are applied in **hydroelectric systems** are:
  - Intakes:  $k = 0.04$
  - Grids:  $k = 0.10-0.15$
  - Contractions:  $k = 0.08$
  - Elbows:  $k = 0.10$
  - Valves, fully open:  $k = 0.10-0.20$
  - Outflow to tailrace:  $k = 1$
- The value of  $k$  is strongly affected by the **shape of the transition**. Well-rounded transitions ensure minimal local losses (which is issue of good design and good construction, as well).
- In **preliminary design studies**, local loss calculations are roughly estimated, since the geometrical details are not yet specified, by considering an aggregate value of  $k$ .

# Local energy losses: Contractions & intakes

- The loss coefficient for a **sudden flow contraction** from a diameter  $D_1$  to a smaller diameter  $D_2$  is approximated by (the formula is valid for  $D_2/D_1 < 0.76$ ; otherwise the numerical coefficient is set to one):

$$k_T \approx 0.42 \left( 1 - \frac{D_2^2}{D_1^2} \right)$$

- For a **gradual contraction**, by applying a coning fitting of angle  $\vartheta = 30\text{-}45^\circ$ , we get  $k_T = 0.02\text{-}0.04$  (the loss coefficient does not depend on the ratio  $D_2/D_1$ ).
- **Intakes** are specific cases of flow contraction, where the transition is made from a free surface of infinite dimensions (e.g. reservoir, tank, forebay) to a pipe of finite diameter  $D$ . Characteristic cases are:
  - Inward-projecting pipe:  $k_T = 1$
  - Square-edged inlet:  $k_T = 0.50$
  - Chamfered inlet:  $k_T = 0.25$
  - Rounded contraction ( $r$ : radius of coning fitting):

$r/D$	0.00	0.02	0.04	0.06	0.10	>0.15
$k_T$	0.50	0.28	0.24	0.15	0.09	0.04

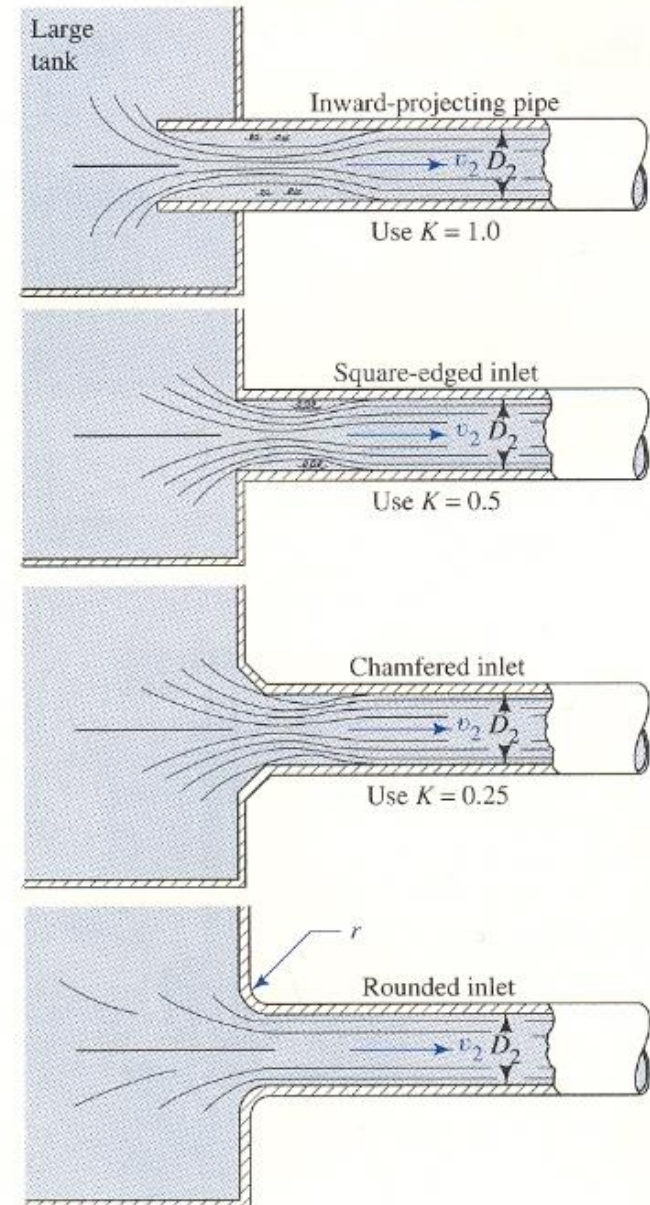

# Local energy losses: Expansions & bends

- The loss coefficient for a **sudden expansion** from a diameter  $D_1$  to a larger one  $D_2$  is:

$$k_T = \left(1 - \frac{D_1^2}{D_2^2}\right)^2$$

- Specific case is the **entrance of a pipe to a tank** (i.e. sudden expansion, with  $\frac{D_1}{D_2} = 0$ , for which we get  $k_T = 1$  (e.g., draft tube, for hydropower works).
- **Changes in direction** cause fluid separation from the inner wall, thus the larger the angle the greater is the head loss. The radius of the bend and the diameter of the pipe also affect the losses. Empirical values are given in the Table.

$r/D$ $\theta$ (deg)	1	1,5	2	4	6	
15	0,03	0,03	0,03	0,03	0,03	Smooth surface
30	0,07	0,07	0,07	0,07	0,07	
45	0,14	0,11	0,09	0,08	0,075	
60	0,19	0,16	0,12	0,10	0,09	
90	0,21	0,18	0,14	0,11	0,09	
15	0,10	0,08	0,06	0,05	0,04	Rough surface
30	0,23	0,19	0,14	0,11	0,08	
45	0,34	0,27	0,20	0,15	0,12	
60	0,41	0,33	0,24	0,19	0,15	
90	0,51	0,41	0,30	0,23	0,18	

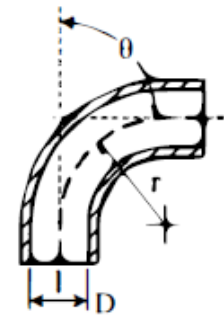

# Local energy losses: Trashracks

- ❑ A trash rack is required at the entrance of penstock to avoid the entrance of floating debris.
- ❑ The flow through the rack also gives rise to a local head loss, estimated by:

$$h_T = \beta \left( \frac{s}{b} \right)^{4/3} \frac{V^2}{2g} \sin \varphi$$

where  $s$  is the thickness or diameter of bars,  $b$  is the net width between adjacent bars,  $\varphi$  ( $^\circ$ ) is the angle of inclination from horizontal,  $V$  (m/s) is the approach velocity, and  $\beta$  is a correction factor that is associated with the shape of bars.

- ❑ The net section  $A_t$  of the rack (total section minus the area of bars) is set to ensure an average entrance velocity from 0.75 to 1.5 m/s.
- ❑ For given  $Q$  and sufficiently cleaned racks we get:

$$\frac{Q}{V} = 0.8 A_t \frac{s}{s+b} \sin \varphi$$

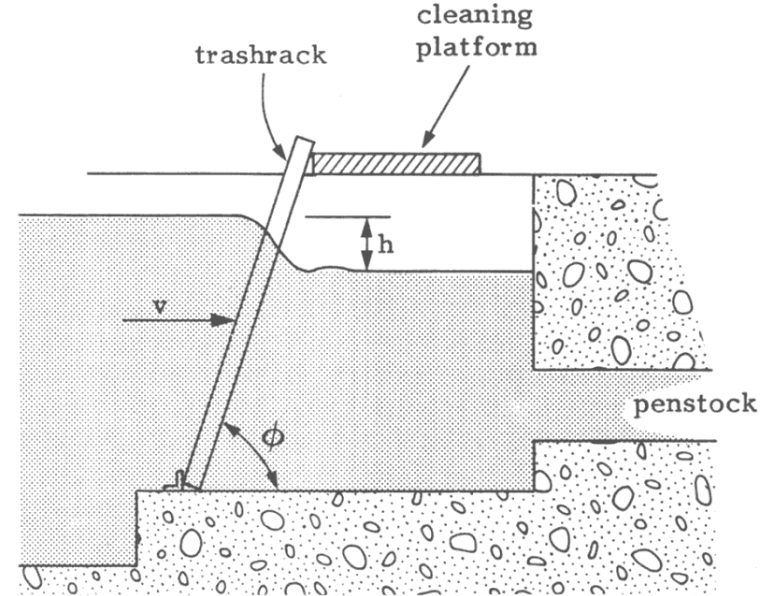

2,42	1,83	1,67	0,92	0,76	1,79

# Examples of trashracks



# Turbines: Key concepts & classification

- A **hydraulic turbine** (from the Latin *turba*, meaning vortex, transliteration of the Greek *τύρβη*, meaning turbulence) is a rotary mechanical structure that converts the available kinetic and pressure energy of water (i.e., expressed in terms of net head) into mechanical work, which is next used for generating electrical power, when combined with a generator.
- In hydroelectric systems, turbines are generally classified into two categories:

- **impulse turbines**, taking advantage of the kinetic energy of water falling from a large elevation (outflow to the atmosphere); the flow velocity is substantially amplified by passing water through a nozzle;
- **reaction turbines**, operating under pressure, as the chamber of the runner remains completely filled by water.

- Turbines are also classified according to the **main direction of flow** as tangential-flow, radial-flow, mixed-flow and axial-flow.
- The selection of the appropriate turbine type is driven by the available **head** (geometrical quantity) and **discharge** (hydraulic quantity).

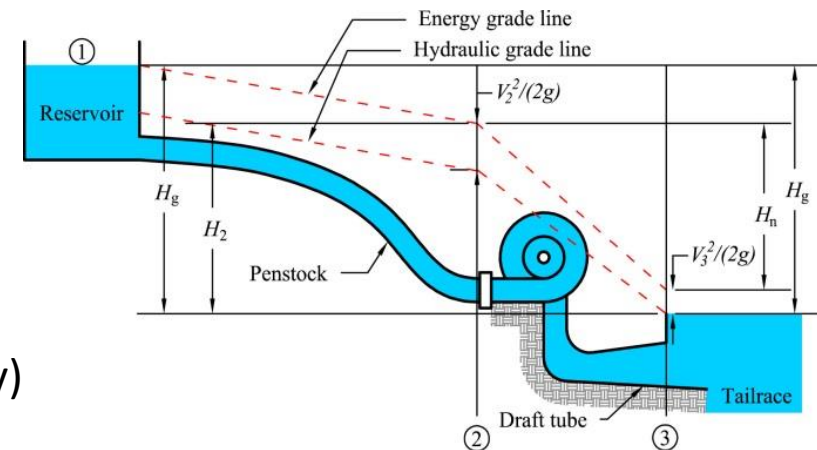
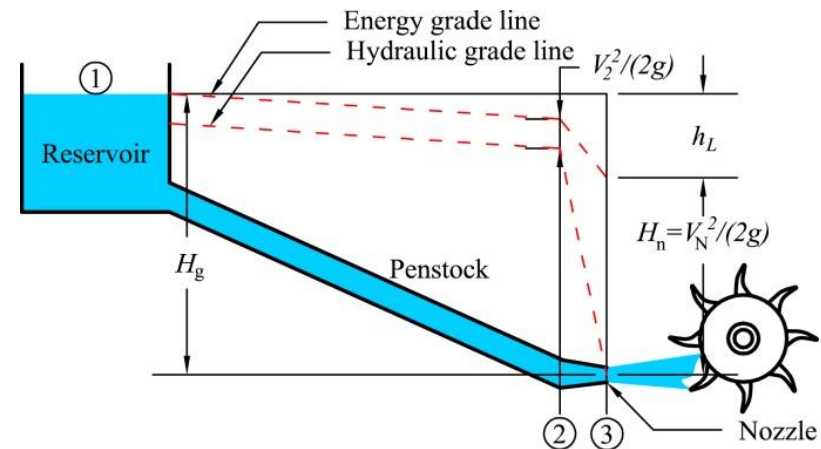

# Impulse turbines

- Widely known as **Pelton wheels**, in honor of the American engineer Lester Allan Pelton, who patented this machine in 1889, by streamlining the traditional windmill technology.
- A jet of water passing from a **contracting nozzle** enters the **double buckets** of the turbine wheel, to produce energy as the runner rotates; after impinging the buckets, the water outflows freely (i.e., under atmospheric pressure).
- Since the jet flow is not axisymmetric, thus only part of the runner is activated (typically only two or three out of about 20 buckets), they are also referred to as **partial admission**.
- The objective is to **substantially increase the flow velocity** from  $V_1$  to  $V_2$ , where  $V_1$  is the velocity through the penstock, with diameter  $D_1$ , and  $V_2$  is the velocity through the nozzle, with diameter  $D_2 \ll D_1$ . If  $Q$  is the discharge, from the continuity equation we get:

$$Q = V_1 \pi D_1^2 / 4 = V_2 \pi D_2^2 / 4 \Rightarrow V_2 = V_1 (D_1/D_2)^2$$

- Generally,  $V_1$  ranges from 4 to 6 m/s, while  $V_2$  may exceed 100 m/s.
- Impulse turbines are applicable for **large heads** ( $H > 150$  m) and relatively **small Q**.
- Large units may have more jets impinging at different locations of the wheel.

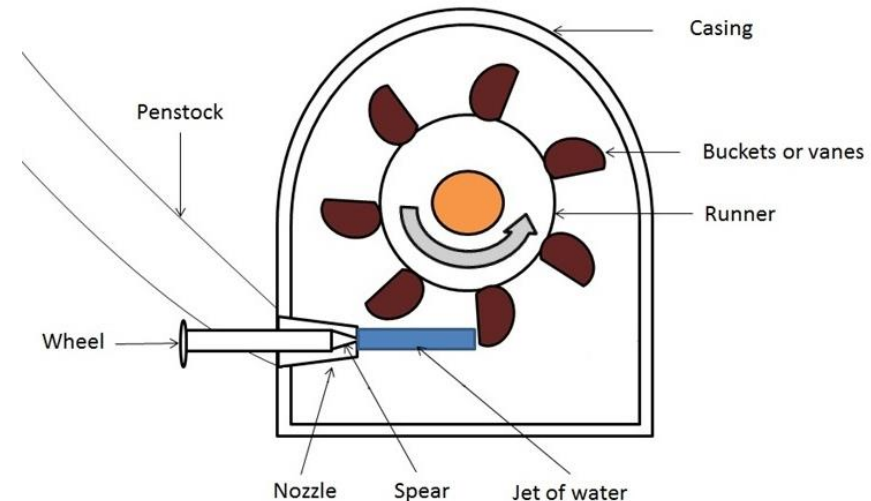
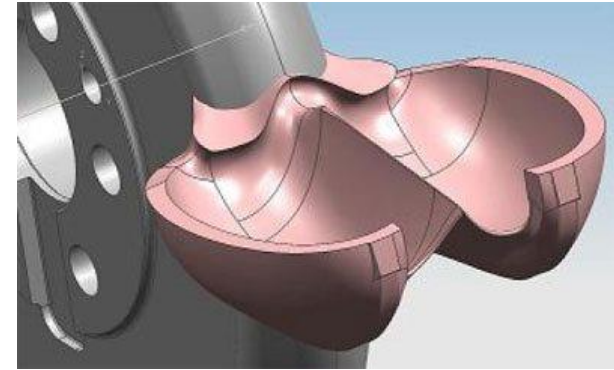

# Impulse turbines: Estimation of hydraulic losses

- General formula for energy loss calculations:

$$h_L = \frac{V^2}{2g} \left[ f \frac{L}{D} + \sum k_{1-2} + k_N \left( \frac{D}{D_N} \right)^2 \right]$$

where  $Q$  is the flow,  $D$  the penstock diameter,  $L$  the penstock length,  $f$  the friction factor,  $\sum k_{1-2}$  the sum of local energy loss coefficient between sections 1 and 2,  $D_N$  the nozzle diameter, and  $k_N$  the local loss coefficient is the transition from the penstock to the nozzle; in typical Pelton machines,  $k_N$  ranges from 0.02 to 0.04.

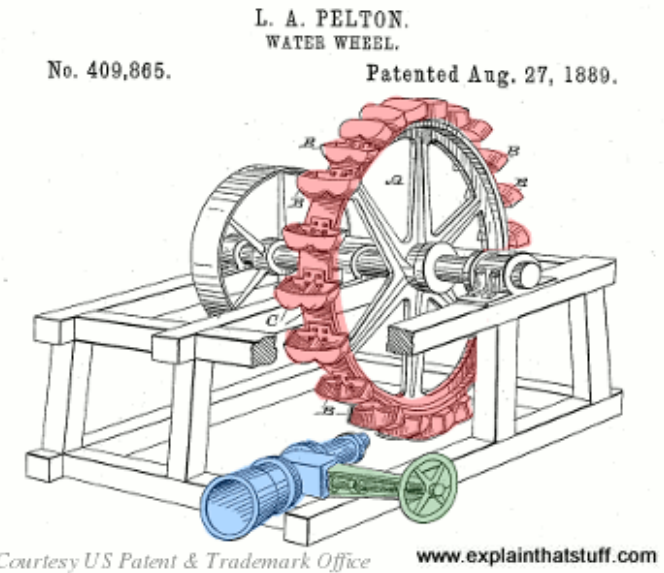

**Remarks:** In Pelton systems the design discharge is generally low, while the diameter of the penstock is large enough, to ensure minimal friction losses across the penstock. An appropriate design of the nozzle ensures minimal local losses due to flow contraction (small  $k_N$ ). Friction losses across the nozzle are omitted since its length is negligible.

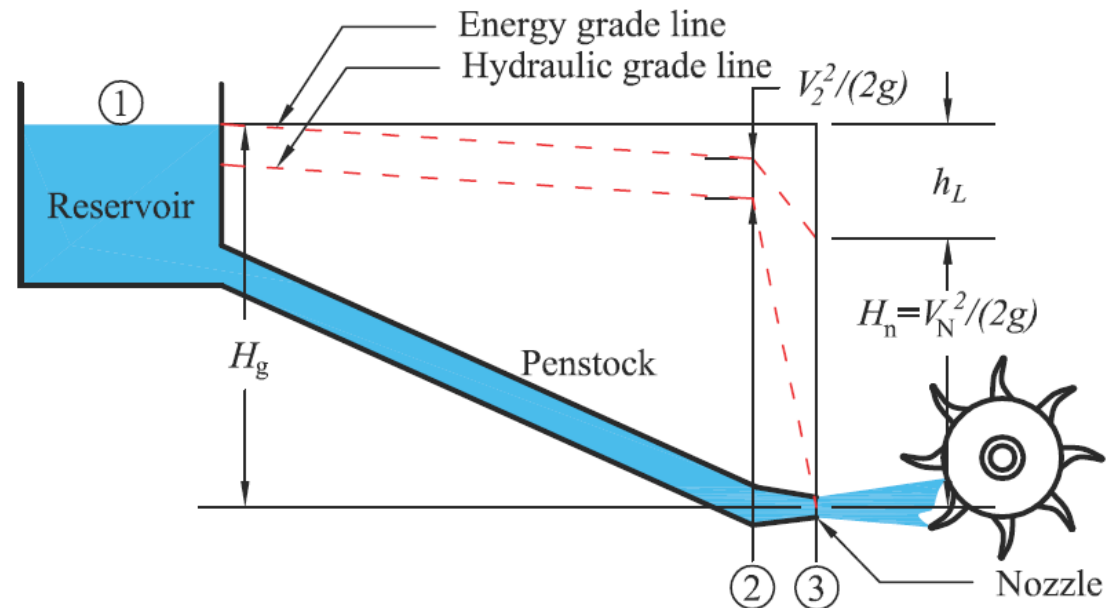



# Other types of impulse turbines

- There also exist other types of impulse turbines that are also applied for low heads and large discharges.
- **Turgo turbines** use single instead of double buckets on the wheel that are shallower than the Pelton ones, thus the runner is less expensive. In contrast to Pelton, the jet is horizontal and has higher specific speed, thus it can handle a greater flow than the same diameter of a Pelton wheel, leading to reduced generator and installation cost. It works with **net heads between 15 and 300 m**, where the Francis and Pelton overlap.
- In **cross-flow turbines** the water passes through the turbine transversely or across the turbine blades, and after passing to the inside of the runner, it leaves on the opposite side. Passing through the runner twice provides additional efficiency, and also allows self-cleaning from small debris, leaves etc. Another advantage of cross-flow turbines is the **practically flat efficiency curve under varying loads**, which makes them ideal for run-of-river plants.

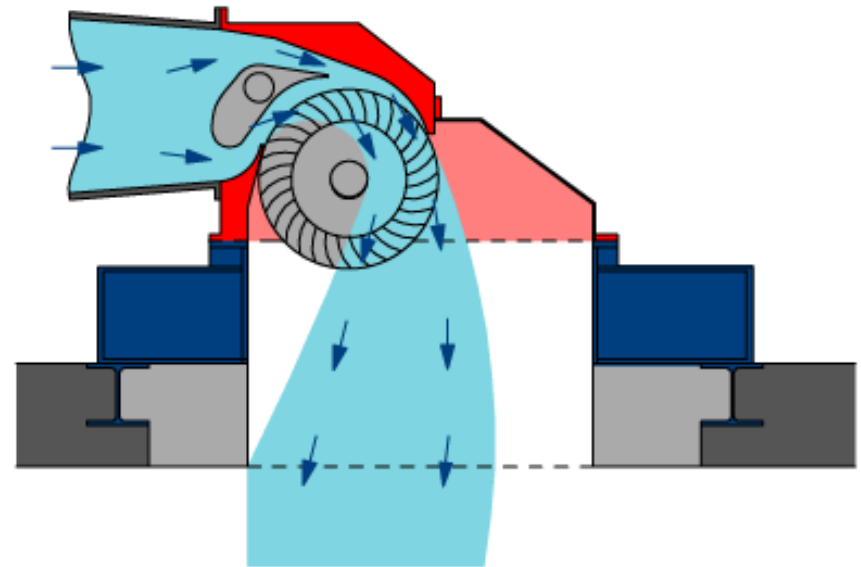
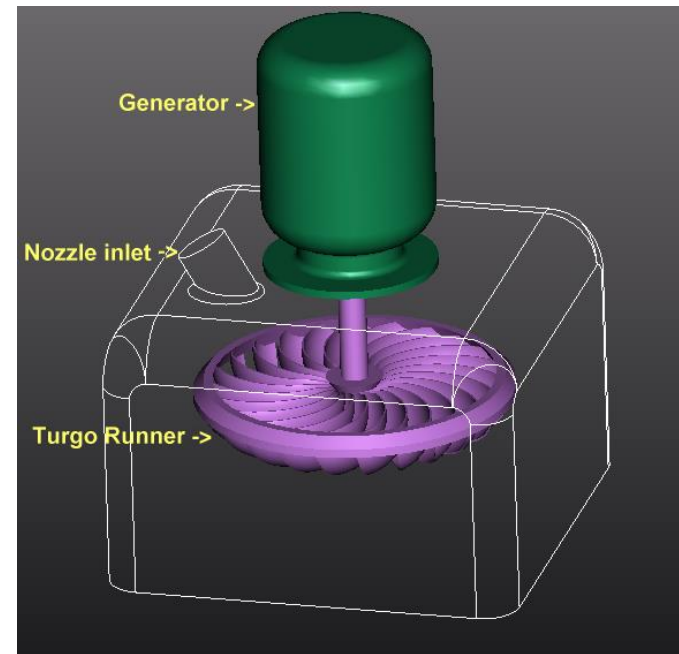

# Reaction turbines

- The flow is **under pressure**, since the chamber of the runner remains completely filled by water. The runner consists of several guide vanes, which **change the direction of flow**, thus producing forces due to change of momentum, which in turn make the runner rotating.
- After leaving the runner, the water enters the **draft tube**, before being extracted to the tailrace. The objective of the draft tube is to convert the mechanical (hydraulic) energy into rotational energy of runner-generator system, while reducing the flow velocity and hence the kinetic energy at the outflow section, i.e. the tailrace. This energy is subtracted from the gross head, thus it is a hydraulic loss for the system.

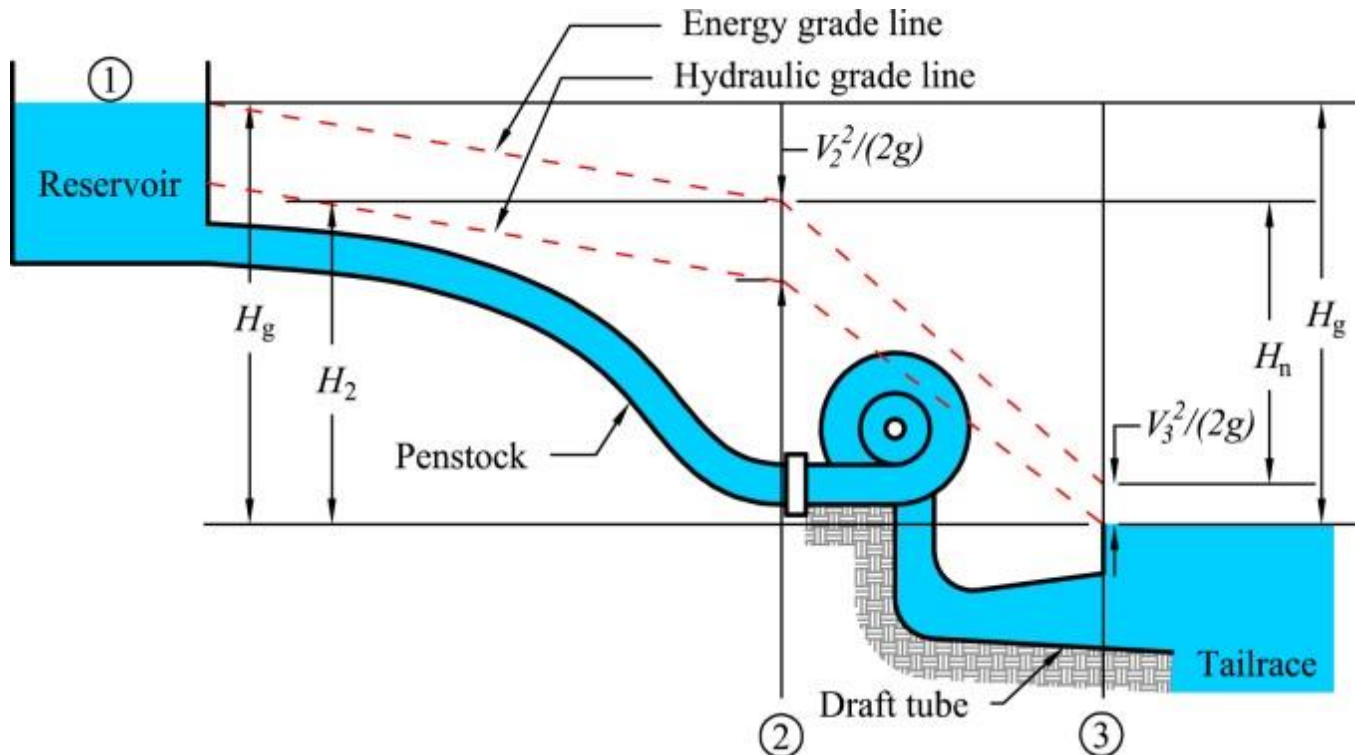

# Reaction turbines: Francis & Kaplan

There are two main types of reaction turbines:

- **Francis turbines**, which are suitable for a wide range of discharge and head conditions, thus they are applied to most of hydroelectric works worldwide (all but two large hydropower systems in Greece employ Francis turbines);
- **Propeller** (also known as **Kaplan**) turbines, which are employed in cases of high-flow and low-head power production, e.g. tidal stations, instream hydropower works at large rivers.

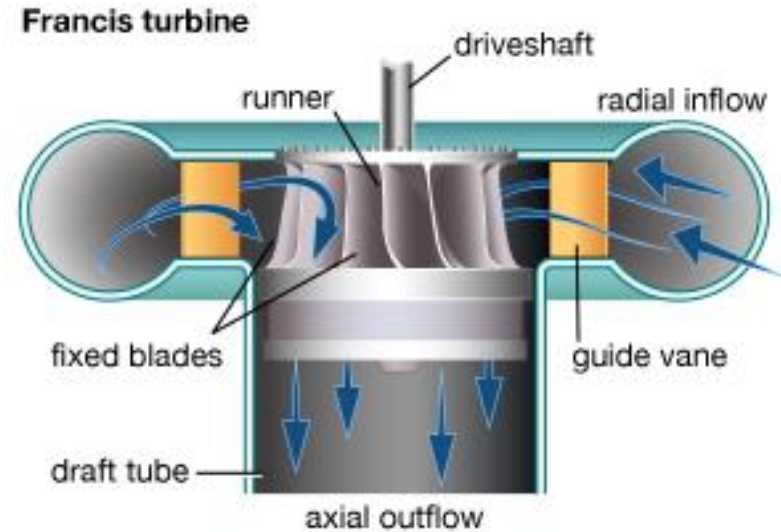

*Francis turbines at Ladonas hydropower station*

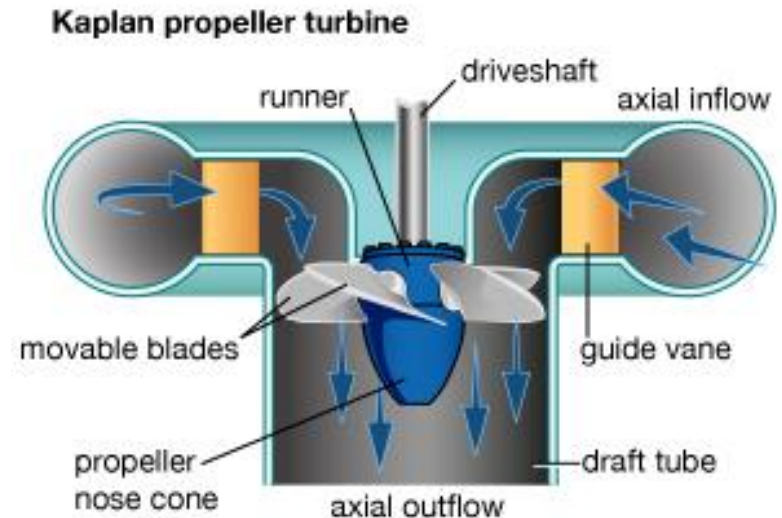

# Range of application of different turbine types

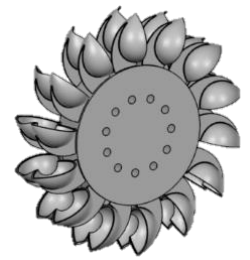
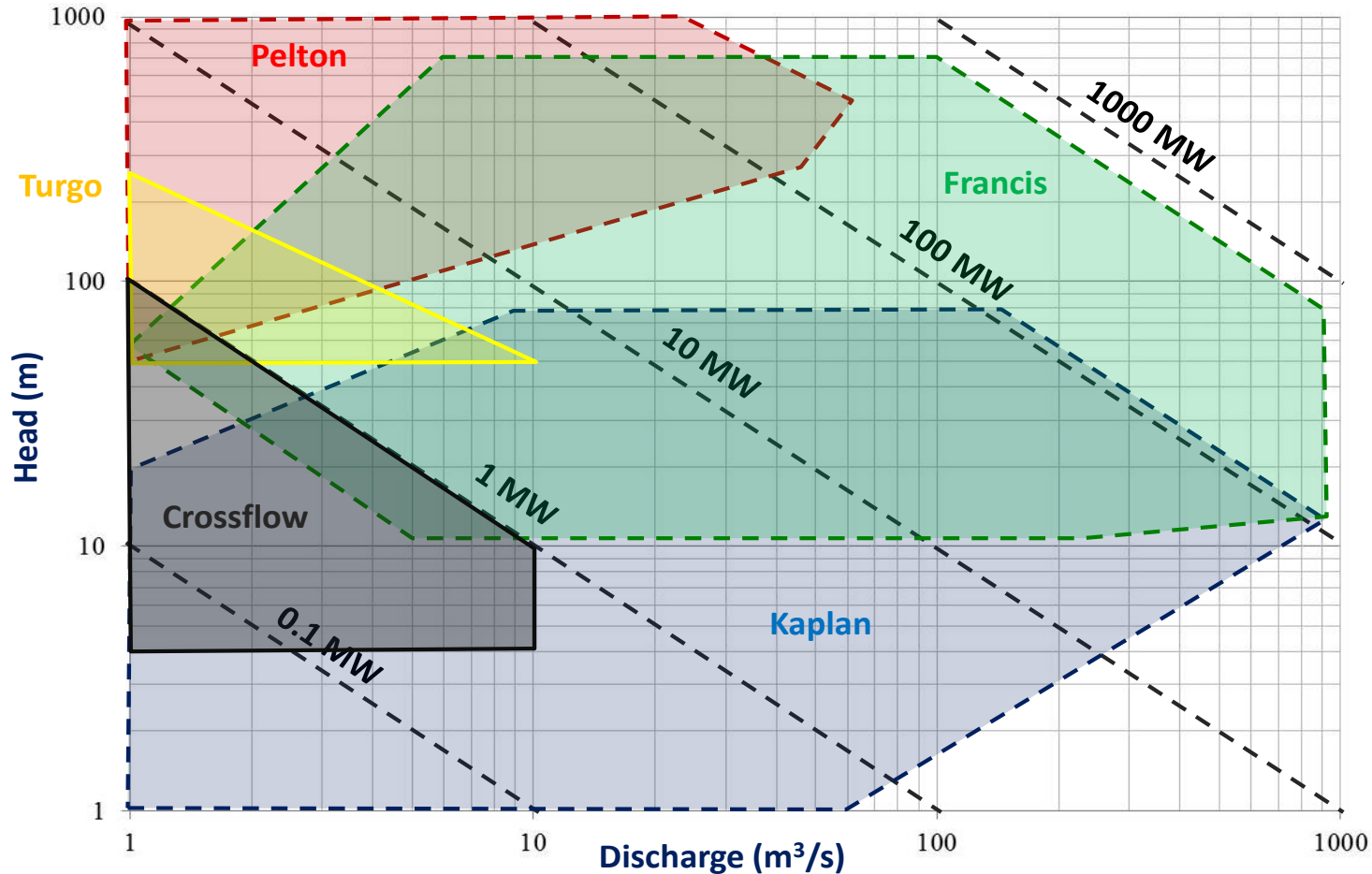

Pelton

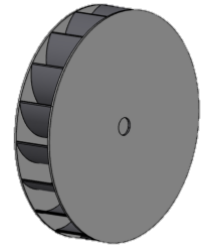

crossflow

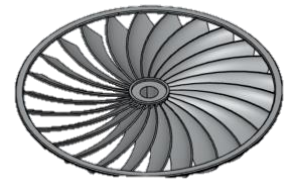

turgo

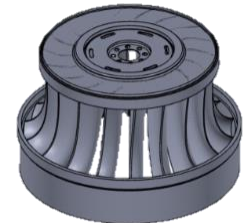

Francis

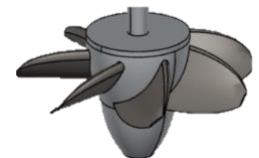

Kaplan

**Remarks:** Since the flow conditions are varying across different turbine types (atmospheric pressure for impulse turbines, pressurized flow for reaction turbines), and their geometrical details also vary, the turbine characteristics affect the net head estimations and, consequently, the determination of the optimal diameter of the penstock.

# Total efficiency and its components

---

- The total efficiency (or simply efficiency,  $\eta$ ) is the ratio of the electric energy provided to the electricity grid to the hydraulic energy provided to the turbine (net head).
- The value of  $\eta$  depends on **scale** (since higher discharges ensure larger efficiencies), and the **turbine type**. For large installations  $\eta$  may reach up to 95%, while small plants, with output power less than 5 MW, the total efficiency may range from 80 to 85%.
- The total efficiency is the product of four individual components, i.e.:

$$\eta = \eta_T \eta_G \eta_{TR} \eta_E$$

where  $\eta_T$  is the efficiency of the **turbines**,  $\eta_G$  is the efficiency of the **generator**,  $\eta_{TR}$  is the efficiency of the **transformer**, and  $\eta_E$  is the efficiency of the **transmission lines**. Typical values for the three latter are 0.96, 0.98 and 0.98, respectively

- The **turbine efficiency** is defined as the ratio of the mechanical energy provided by the turbine to the net head. The difference between the two energy quantities is due to:
  - **Hydraulic losses**, due to friction losses of the fluid layers in motion, friction losses due to water crash on blades, local losses due to changes of tube section, etc.;
  - **Volumetric losses** (only for impulse turbines), due to small amounts of water that are extracted to the atmosphere, without crashing on the blades;
  - **Mechanical losses** that are developed in the rotating parts of the turbine.
- Typical values for the aforementioned efficiencies (i.e., hydraulic, volumetric, mechanical) are 0.90-0.96, 0.97-0.98 (only for impulse turbines) and 0.97-0.99, respectively.

# Performance curves

- Although in preliminary design and management studies the efficiency is considered constant, it is actually function of **head** and **flow**. Both are **varying**, e.g., due to fluctuations of the upstream level.
- The variation of  $\eta$  against head and flow, for different gate opening ratios, is typically expressed by means of **nomographs** that are **experimentally** derived and provided by the manufacturer of the turbine.
- For any turbine there exists a **theoretically optimal efficiency** that is achieved for a unique combination of head and discharge.
- In real-world systems, the operation of the turbine is determined by the **head-discharge relationship of the penstock**, i.e.  $H_n = H - \Delta h(Q)$ , dictating a feasible range of operation. Across this range,  $\eta$  may vary significantly, also taking quite low values.

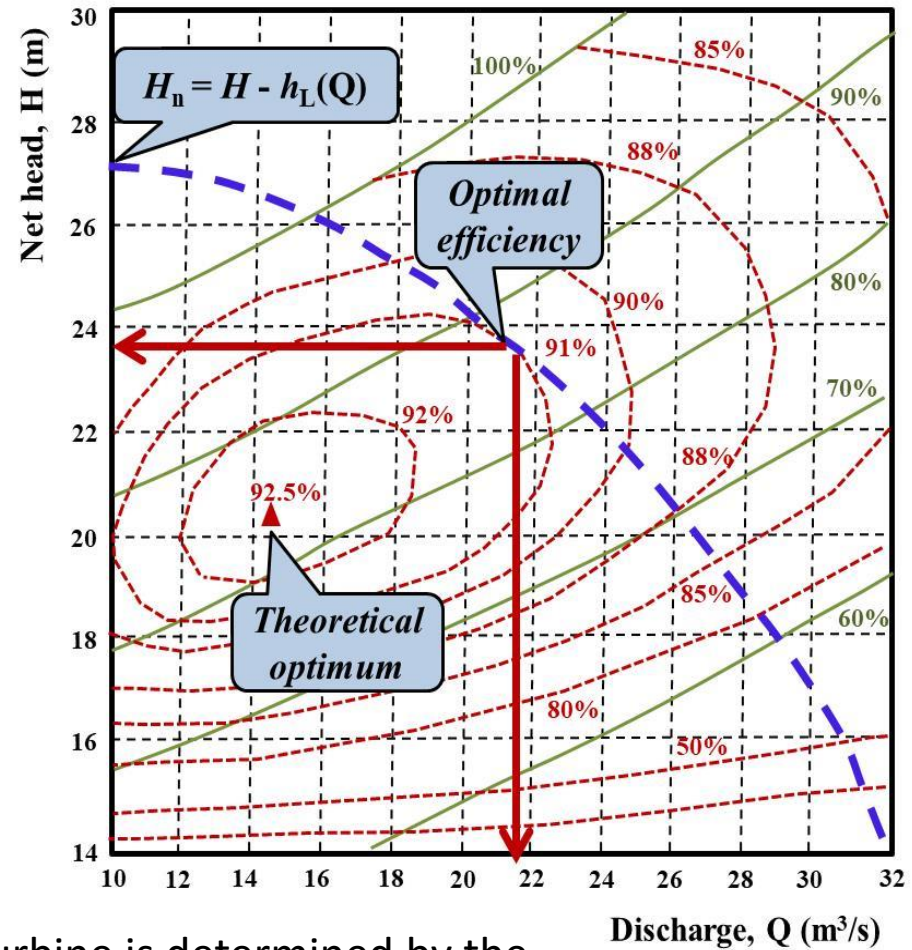

**Remarks:** Key design objective is to ensure that the turbines will mostly operate close to their theoretically optimal efficiency, thus providing a head-discharge curve that passes as close as possible to this point. In **hydroelectric reservoirs**, this is achieved by properly tuning the opening of turbine gates, thus adapting the outflow to the given head conditions.

# Remarks on turbine efficiency

---

- The turbine efficiency and the hydraulic head can be much lower than the corresponding design values, which refer to nominal (rated) flow conditions.
- Rated efficiency increases as the size of the turbine increases (scaling law).
- The efficiency curve for specific turbine dimensions (e.g., diameter runner) is usually expressed by means of nomographs, as **percentage of rated flow**,  $q_T/q_{max}$ .
- **Nomographs** are provided by the turbine manufacturer and they are obtained by data extrapolation from a **reduced scale model**. Since it is not possible to exactly preserve dynamical, geometrical, and kinematical similarity between the model and the prototype, it is also not possible to precisely estimate the efficiency.
- Although **empirical corrections** are employed to better reflect the prototype performance, actual efficiency is unknown, since it also depends on **technical and operational characteristics** of the power plant, as well as changes due to **deterioration, damage and aging** of the equipment over time.
- Pelton, Crossflow and Kaplan machines retain high efficiency even when running below their design flow; in contrast the efficiency of Francis turbines falls away sharply if run at below half its normal flow.
- The impacts of varying efficiency are much more important in the case of **small hydroelectric works**, in which the flow entering the turbines is not regulated due to the absence of storage capacity.

# Efficiency curves for different turbine types

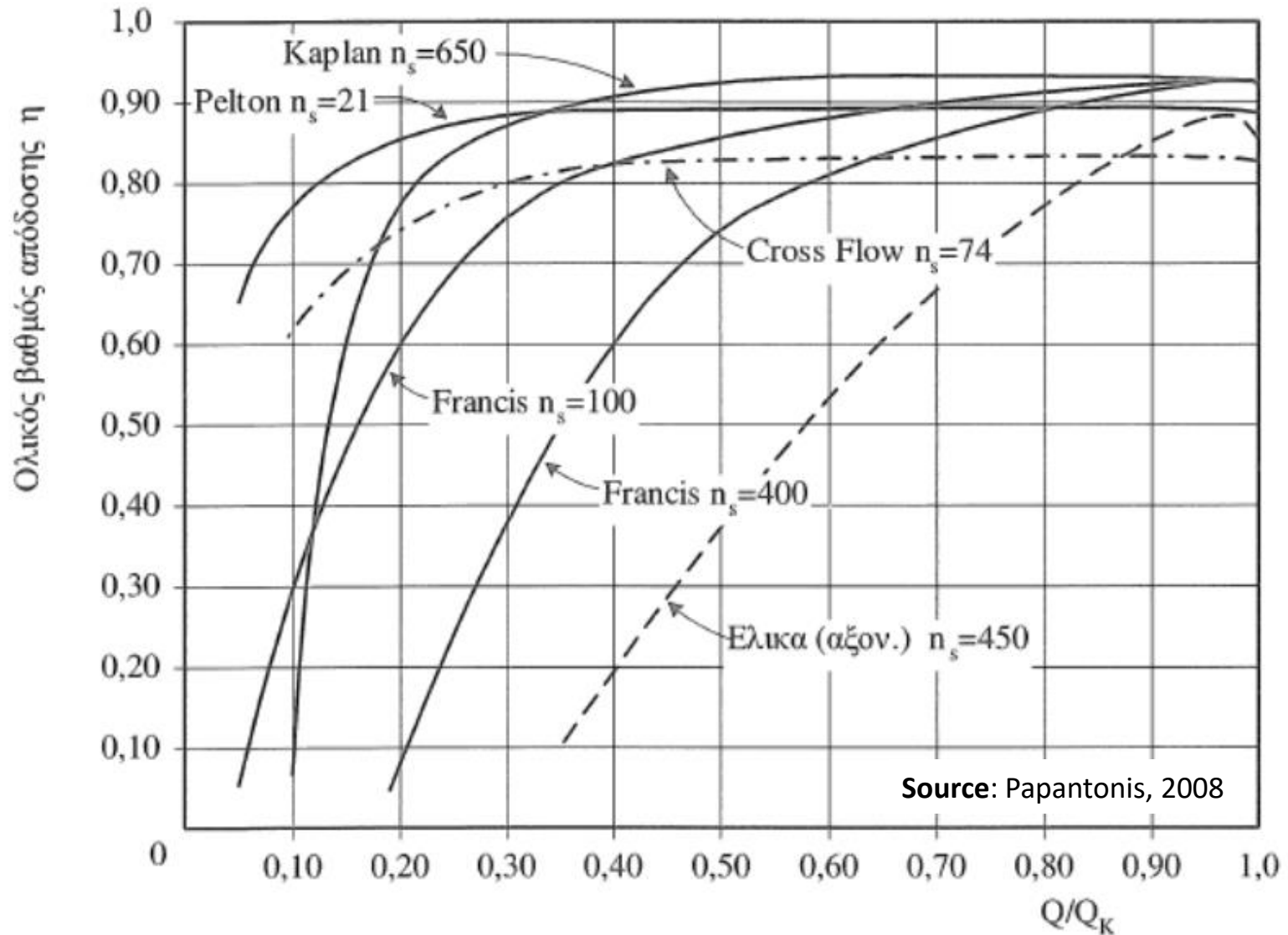



# Flow regulation for different turbine types

- The use of a proper **flow regulator** inside the turbine allows its characteristic curve and the associated curve of the pipe losses for matching each other, and guarantee an efficiency always close to its maximum value. If pipe energy losses are negligible, this is equivalent to keep a constant hydraulic head for all possible discharge values.
- The regulation is made either with **hydraulic** or **electrical** means. The hydraulic regulation is often more flexible and efficient, and depends on the type of turbine, i.e.: needle stroke for **Pelton**; adjustable guide vanes for **Francis**; fixed or adjustable guide vanes or adjustable runner blades for **Kaplan**.
- Pelton turbines can have multiple needles, which can be set in on/off position, according to the available discharge.
- A **high part-flow efficiency** can be maintained at less than a quarter of full flow by the arrangement for flow portioning illustrated in the figure. At low flows, the water can be conveyed through either two-thirds or one third of the runner, thus sustaining a relatively high turbine efficiency.

